

UTP7216E-L2



- Provides 16*10/100Mbps downlink Ethernet ports and 2*10/100/1000Mbps uplink Ethernet ports ; 2* 1000Mbps uplink SFP ports;
- Provide web-based layer 2 network management by simple operation;
- Support high-speed data forwarding, perfectly designing for large flow of video data forwarding in security surveillance;
- Support one-key recovery of IP address & user password;
- Excellent isolated circuit protection, lightning protection up to 6 KV;
- Quickly fixing, easily operation and convenient for wall/ desk/ rack installation.



Introduction

The 16-port managed Ethernet switch, provides 16*100Mbps downlink Ethernet ports and 2*1000Mbps uplink optical ports and 2*1000Mbps uplink Ethernet ports. The switch support Layer 2 network management based on web and provides high-speed data forwarding. It is widely used in security surveillance, network engineering projects and so on.

Application

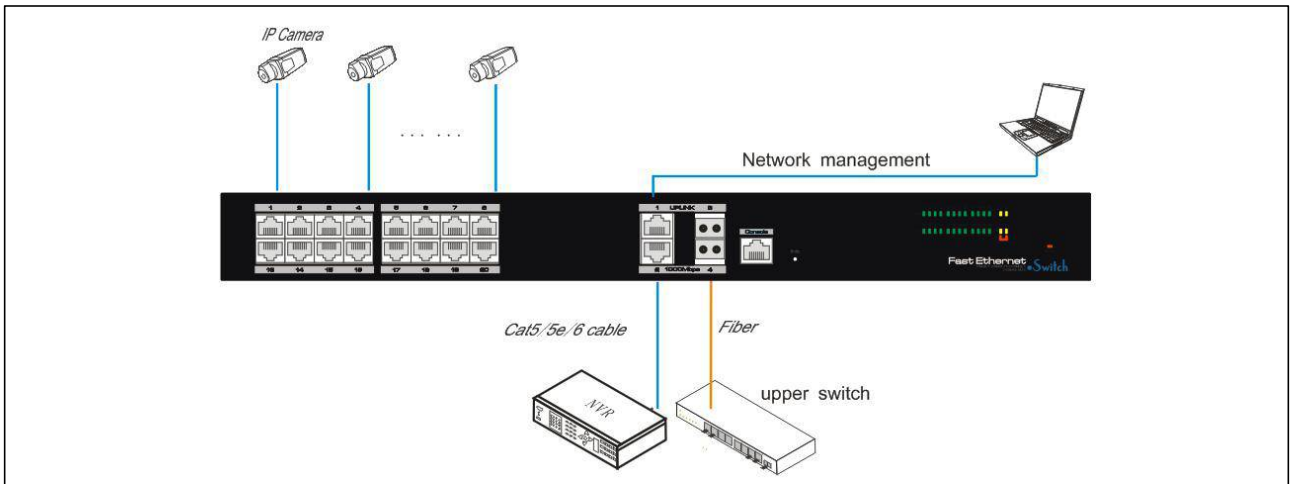

Physical Features

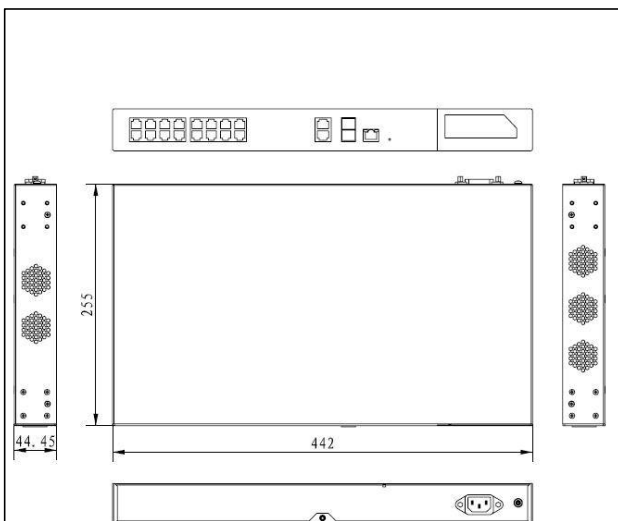

Interface drawing

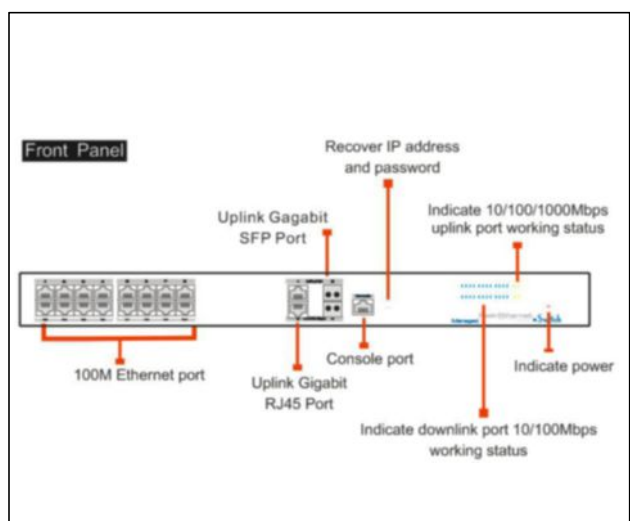

Specification

Hardware Features :

型号	UTP7216E-L2
Downstream Ports	16* 10/100Base-TX
Uplink Ports	2*1000Mbps SFP Port and 2*10/100/1000Base-T
Network Standard	IEEE802.3、IEEE802.3u、IEEE802.3ab、IEEE802.3z、IEEE802.3X、IEEE 802.1Q IEEE 802.1p IEEE 802.3ad、IEEE 802.1D、IEEE 802.1X
Switch Capacity	11.2Gbps
Throughput	8.33Mpps
Switch Processing Scheme	Store and Forward
MAC Table	16K
Lightning protection	6KV Execute : IEC61000-4-5
ESD	6KV Contact discharge 8KV Air discharge Execute : IEC61000-4-2
Power Supply	100~240V AC: 50/60Hz
Power Dissipation	<50W
Work temperature	-10°C~50°C
Storage temperature	-40°C~85°C
Humidity(Non-condensin)	5%-95%
Dimension (L×W×H)	442mm×255mm×44.5mm
Weight	3.73kg
Regulator	CE、FCC、ROHS

Software Features :

Port Management	Support port enabling and disabling
	Support port speed settings
	Support port full-duplex mode
	Support IEEE802.3x flow control
	Support port name modification
VLAN	Support of 4K VLAN
	supports 802.1Q VLAN protocol
	Support VLAN based on port
QoS	Support QoS Congestion Management
	Support 8 priority queues
	Queue scheduling: SP, WRR, SP+WRR
	Support 802.1p CoS/DSCP priority

Multicast Management	Support SNMPV1 / V2 / V3 protocols
	Support IGMP Snooping
Security Features	Supports IP, MAC, port, VLAN binding combinations
	Support MAC address auto-learning, aging and filtration
	Support port isolation, port speed limit
	Support RSTP
	Support 5 groups of link aggregation
	Support 802.1X
System Management	Web-based GUI and CLI management
	Support FTP / TFTP / HTTP load upgrade
	Support traffic statistics
	Support MAC address table query
	Support IP address, DNS server modifications
	Support user name and password modification
	Support for history, log management
	Support System Configuration Backup
	Support to recover the default factory settings on reboot

Package List

Designation	Quantity
UTP7216E-L2	1
AC Power Line	1
Mounting brackets	1
User Manual	1

Related Products

Designation	Model
24 Ports Fast Managed Ethernet Switch	UTP7224E-L2
24 Ports PoE Managed Ethernet Switch	UTP7224E-PoE-L2